

FUMEX®

ME 100



The ideal extractor for light industry and laboratory environments.

With its optimal design, the \varnothing 100 mm FUMEX ME has a very low pressure drop, which provides many valuable benefits.

- Low pressure drop saves energy.
- Air flow noise is reduced.
- Lower pressure drop is achieved without selecting a larger diameter extractor.
- Lower pressure drop allows the ME to be combined with additional extraction systems.

To further facilitate maneuvering of the extractor, the models 1650 and 1900 are equipped with a pulling gas spring as standard and the models 2100 and 2650 with two pulling gas springs.

An easy-to-grip handle facilitates the maneuverability of the extractor.

Unique design and stable mounting brackets make the Fumex ME your best choice.

Support for designing an effective system can be found on page 5, and at www.fumex.com where you will find our design tool and CAD drawings.

The Fumex range also includes fans, accessories, automatic control and filters suitable for local extraction.

LOCAL EXTRACTION
Pure advantages

FUMEX® ME 100

Always choose a low pressure drop

Lowest possible pressure drop is a quality aspect that always should be considered.

With its uniquely designed joint construction, Fumex ME combines maximum flexibility with low pressure drop. The air passes through the joints without creating unnecessary turbulence, thus producing an energy-saving low pressure drop and a quieter working environment.



Recommended air flow

The recommended air flow for a $\varnothing 100$ arm is 200-300 m³/h, See table and diagram.

Activity	Air flow	
Laboratories	200-300 m ³ /h	55-80 l/s
Light industry	300 m ³ /h	80 l/s

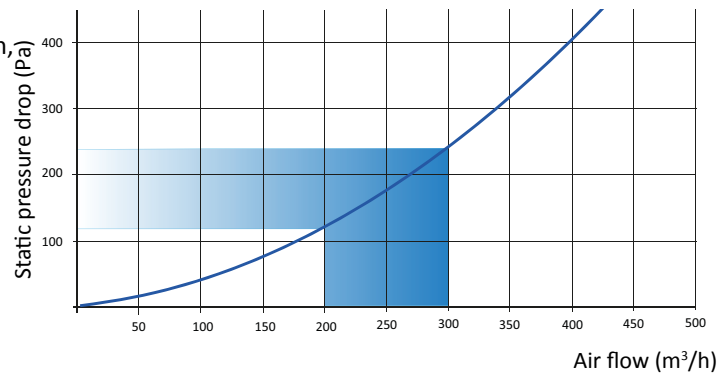

Static pressure drop is measured in accordance with ISO standard 5167-1.

Optimal capture

For optimum benefit from the local extractor, it is important to use the flexibility of the extractor to get as close to the contaminant as possible. A good rule of thumb would be a distance of 2-3 times the diameter of the extractor tube. At the recommended air flow, the extractor will provide high efficiency even if disturbances are generated in the surroundings.

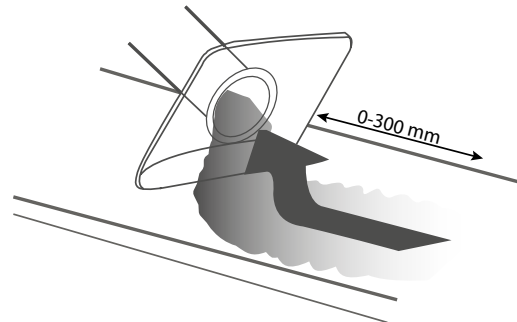

Unique benefits

The Fumex ME's joints have a patented friction design that, combined with the large joint diameter and single grip handle, provide a secure, position-stable arm with smooth adjustments. All without the need to apply excessive force or use tools on the adjusting knob.

Joints with reinforced ends and ball bearings moderate the friction and allow the arm to be moved up and down while maintaining stability and function.

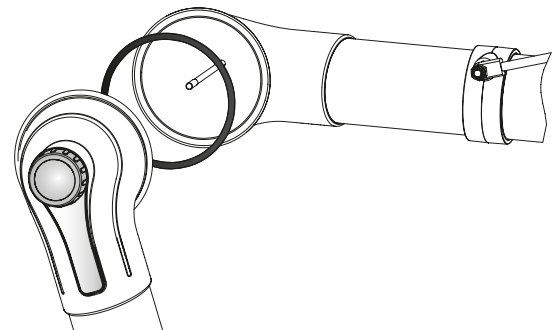

Handle for easy adjustment

A steady and easily accessible handle, that provides easy adjustment, is fitted as a standard on all models of Fumex ME $\varnothing 100$ mm.



FUMEX® ME 100

One arm. All options.

Fumex ME has a complete range of accessories to suit every situation, enabling you to create the optimal extractor for the evacuation of hazardous airborne gases and particulates.



Standard version

Suitable for evacuating most types of airborne contaminants, e.g. in laboratories, schools, hospitals, the pharmaceutical industry, nail salons and light industrial applications.



PP version

Used primarily for evacuating very corrosive contaminants in high concentrations, e.g. in certain laboratories and in the pharmaceutical and chemical industries.



ATEX version



Suitable for evacuating airborne contaminants where there is a requirement for an ATEX-classified environment, e.g. in laboratories, the chemical and petrochemical industries, gas distribution, and the paint and pharmaceutical industries.



FUMEX® ME 100

MET for ceiling and wall mounting, 3 joints

Standard	Size (mm)			Gas spring pcs.	Weight (kg)
	A	B	Ø C		
MET 1150-100	450	350	100	0	4,9
MET 1350-100	550	450	100	0	5,4
MET 1650-100	750	550	100	1	5,9
MET 1900-100	1000	550	100	1	6,4
MET 2100-100	1000	750	100	2	6,9
MET 2650-100	1300	1000	100	2	7,4

PP	Size(mm)			Gas spring pcs.	Weight (kg)
	A	B	Ø C		
MET 1150-100PP	450	350	100	0	4,9
MET 1350-100PP	550	450	100	0	5,4
MET 1650-100PP	750	550	100	1	5,9
MET 1900-100PP	1000	550	100	1	6,4
MET 2100-100PP	1000	750	100	2	6,9
MET 2650-100PP	1300	1000	100	2	7,4

ATEX	Size (mm)			Gas spring pcs.	Weight (kg)
	A	B	Ø C		
MET 1150-100EX	450	350	100	0	4,9
MET 1350-100EX	550	450	100	0	5,4
MET 1650-100EX	750	550	100	1	5,9
MET 1900-100EX	1000	550	100	1	6,4
MET 2100-100EX	1000	750	100	2	6,9
MET 2650-100EX	1300	1000	100	2	7,4

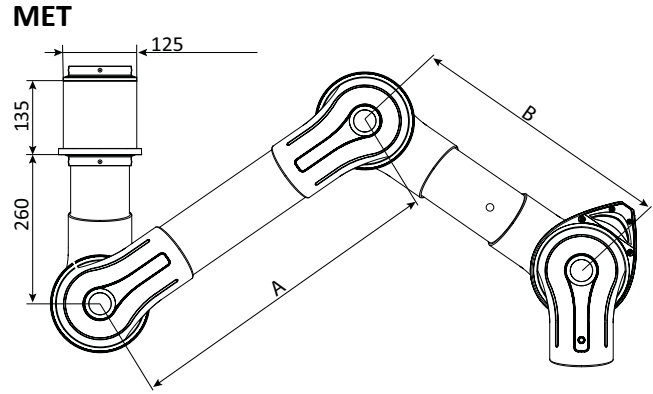

MET for ceiling mounting, excluding ceiling bracket MTI.
MEV for wall mounting, including wall bracket MVK.

Pressure drop

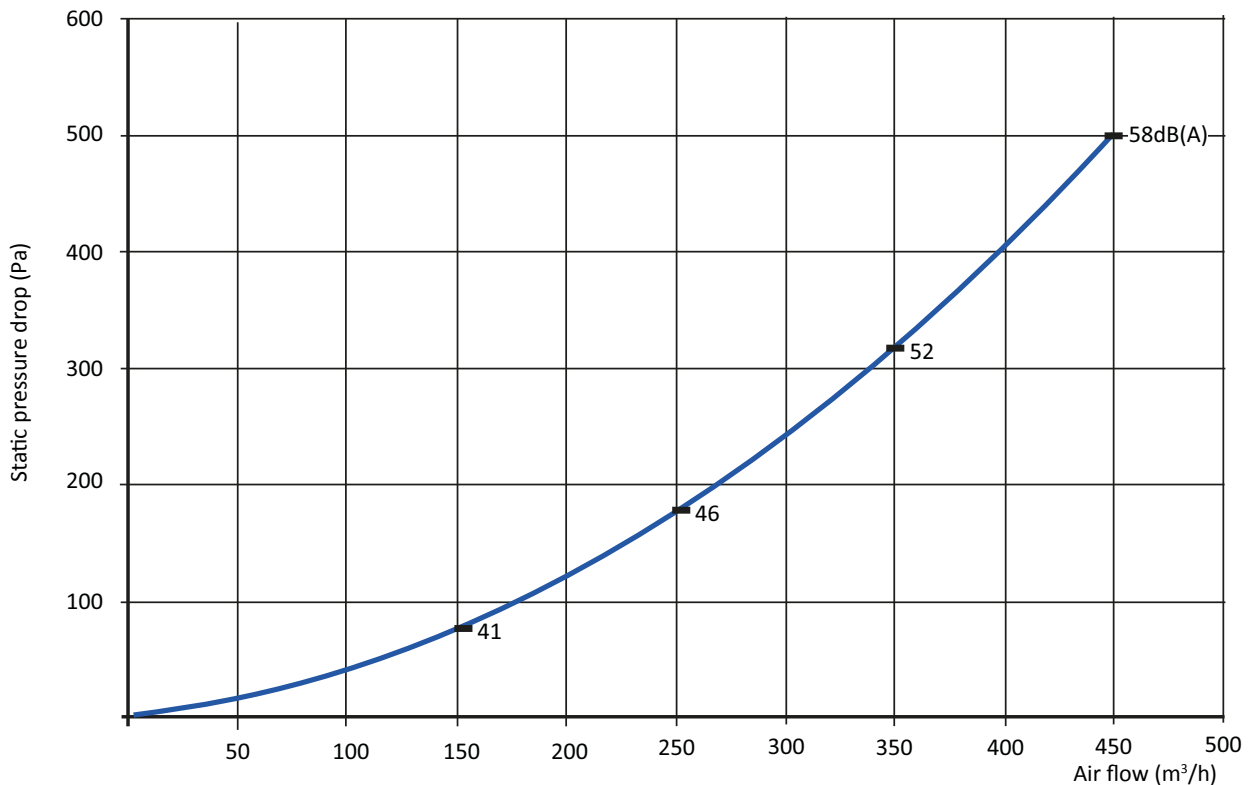

Static pressure drop is measured in accordance with ISO standard 5167-1.

Noise level is measured in accordance with ISO standard 3743.

Indicated sound level refers to sound pressure level.

FUMEX® ME 100

MEB for table mounting, 3 joints

Standard	Size (mm)			Gas spring pcs.	Weight (kg)
	A	B	∅ C		
MEB 1150-100	450	350	100	0	4,9
MEB 1350-100	550	450	100	0	5,4
MEB 1650-100	750	550	100	1	5,9
MEB 1900-100	1000	550	100	1	6,4

PP	Size (mm)			Gas spring pcs.	Weight (kg)
	A	B	∅ C		
MEB 1150-100PP	450	350	100	0	4,9
MEB 1350-100PP	550	450	100	0	5,4
MEB 1650-100PP	750	550	100	1	5,9
MEB 1900-100PP	1000	550	100	1	6,4

ATEX	Size (mm)			Gas spring pcs.	Weight (kg)
	A	B	∅ C		
MEB 1150-100EX	450	350	100	0	4,9
MEB 1350-100EX	550	450	100	0	5,4
MEB 1650-100EX	750	550	100	1	5,9
MEB 1900-100EX	1000	550	100	1	6,4

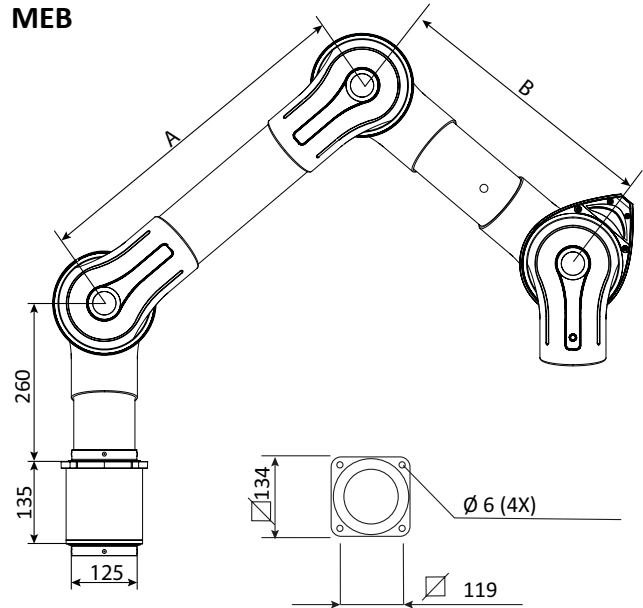

Reach at recommended installation height

The following installation heights and sideways displacement relative to the work area are recommended for optimal extraction:

Recommended installation height

Designation	H (mm)
MET 1150-100	1700-2000
MET 1350-100	1900-2200
MET 1650-100	2000-2300
MET 1900-100	2200-2500
MET 2100-100	2300-2500
MET 2650-100	2300-2500

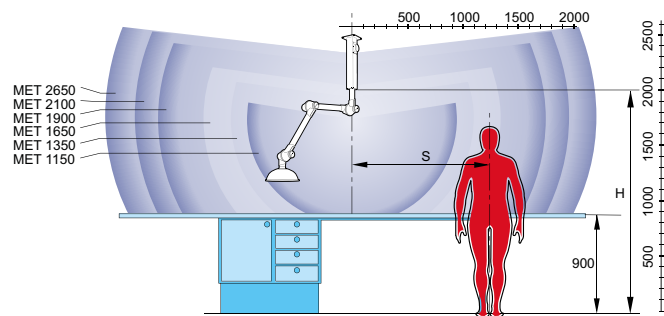

Recommended side displacement

radius, relative to work area

Designation	S (mm)
MET 1150-100	300-600
MET 1350-100	400-700
MET 1650-100	500-800
MET 1900-100	700-800
MET 2100-100	700-900
MET 2650-100	900-1300

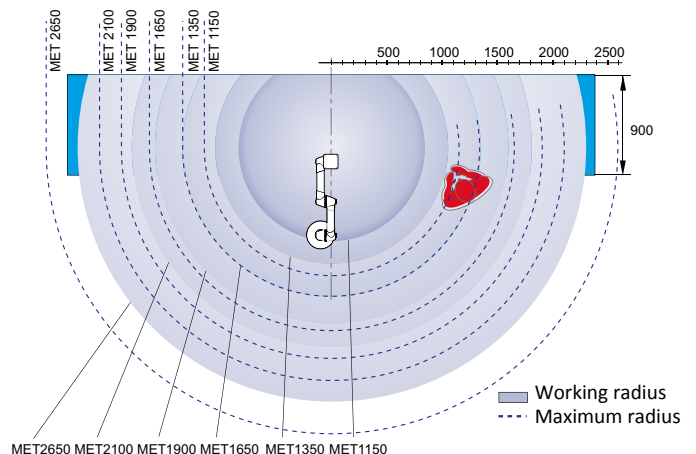

FUMEX® ME 100

Hoods

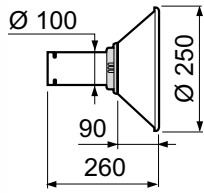

METAL HOOD

The metal hood is used when working in corrosive environments and for capturing hot gasses and dust splatter. Metal hoods can be fitted with work lighting.
Temp. range: -15°C to +80°C

Standard	Variants	Vikt (g)
MEM 251-100	PP, EX	510

Material
Standard/PP: Powder-coated aluminium
EX: Powder-coated aluminium

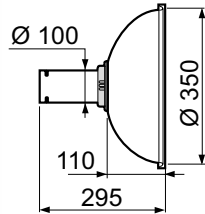

DOME HOOD

The clear dome hood is suitable for lighter gasses with a wider dispersal of contaminants without blocking the user's vision.
Temp. range: -15°C to +80°C

Standard	Variants	Vikt (g)
MEK 351-100	PP, EX	610

Material
Standard: PMMA
PP: Polypropylene, transparent
EX: PEEL black

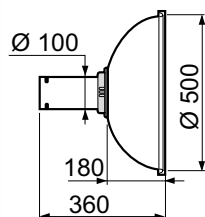

DOME HOOD

The clear dome hood is suitable for lighter gasses with a wider dispersal of contaminants without blocking the user's vision.
Temp. range: -15°C to +80°C

Standard	Variants	Vikt (g)
MEK 500-100	PP, EX	735

Material
Standard: PMMA
PP: Polypropylene, opaque
EX: PEEL black

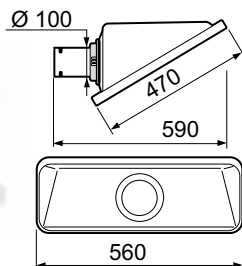

SQUARE HOOD

The square hood is suitable for placing above gasses with a high lift, or adjacent to the work surface for contaminants with no lift or low lift – all this without interfering with the work.
Temp. range: -15°C to +80°C

Standard	Variants	Vikt (g)
MESH 500-100		1125

Material
Standard: PETG

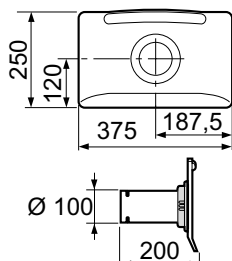

FLAT SCREEN HOOD

The flat screen hood is designed to maximise the working area without obscuring the object from the user. The flat screen hood gives the best suction effect for table and bench tasks.
Temp. range: -15°C to +80°C

Standard	Variants	Vikt (g)
MEPH 375-100	PP, ES, EX	625

Material
Standard: PETG
PP: Polypropylene
EX: PEEL black



PROTECTIVE GRILL

Protective grill to be monted in joints. Prevents objects being sucked into the system.
Temp. range: -15°C to +80°C

Standard	Variants	Vikt (g)
MESG-100	EX	12

Material
Standard, EX: EN 1.4436

FUMEX® ME 100

Brackets



All Fumex laboratory extractors have as standard a full swivel that allows 360° of rotation without the need to add special sleeve couplings.

Both ceiling and wall brackets have a special square-shaped profile in anodised aluminium to provide a stylish and stable installation. This aluminium profile also allows both the wall and ceiling brackets to be custom tailored at the job site.

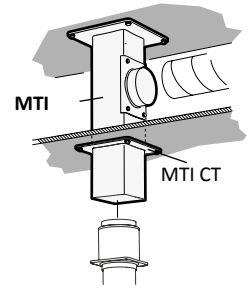

The MTI ceiling bracket

The ceiling bracket functions as a simple and stable duct for outgoing air, avoiding the need for expensive ducting and additional holes through false ceilings. On request, the MTI can be supplied in lengths exceeding 2 m.

Standard	Dimensions (mm)	Weight (kg)
	L	
MTI 500-125	500	4,90
MTI 750-125	750	5,80
MTI 1000-125	1000	6,75
MTI 1250-125	1250	7,65
MTI 1500-125	1500	8,60
MTI 1750-125	1750	9,50
MTI 2000-125	2000	10,40

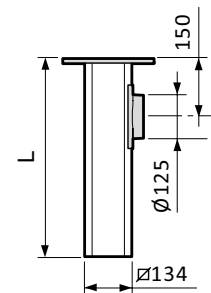
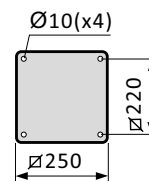
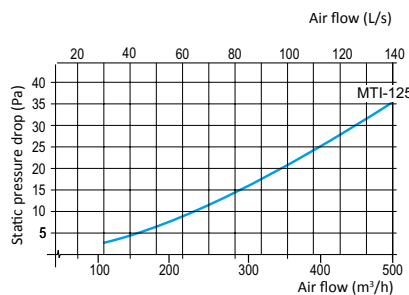

The MTF ceiling bracket

Ceiling bracket, for fitting through beams. The attachment plate is adjustable for the entire length of the aluminium profile. If required, the aluminium profile can be cut during fitting.

Standard	Dimensions (mm)	Weight (kg)
	L	
MTF-125	1000	5,50

As well as the standard design, the MTI/MTF is available in an ATEX (EX) version.

The ceiling brackets can be supplied with an epoxy-coated exterior in all lengths up to 3 m (L).

For aggressive environments, we recommend epoxy coating on the interior and exterior up to 1.25 m (IL).

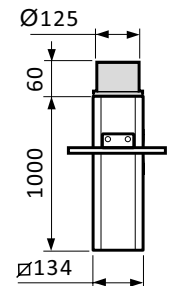
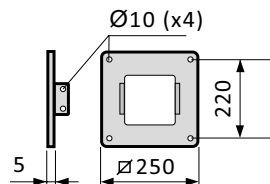

The MTI CT escutcheon plate

Escutcheon plate, used with the MTI ceiling brackets for stabilization and to cover ducting in false ceilings.

Standard	Weight (kg)
MTI CT-125	0,125

As well as the standard design, the escutcheon plate is available in an ATEX (EX) version.

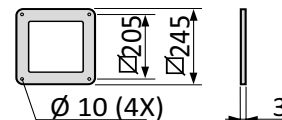

MVK wall bracket

Included as standard for a wall-mounted arm.

Wall brackets can be special ordered in custom horizontal and vertical lengths.

Standard	Weight (kg)
MVK-125	2,5

As well as the standard design, the bracket is available in an ATEX (EX) version.

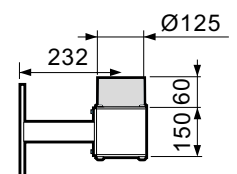
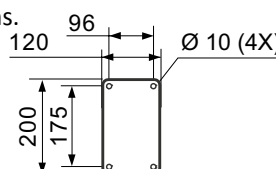



Material description

Friction joints

Ball bearing-equipped adjustable friction joints in polypropylene (PP), with guide ring in low friction-treated rubber. Support springs and other component parts in zinc-plated steel or stainless steel.

Tubes

Made from thin-walled anodised aluminium or from polypropylene. Air-tight damper supplied as standard.

ME Standard

The standard ME version has polypropylene joints and anodised aluminium tubes.

The standard ME version is suitable for evacuating most types of airborne contaminants, e.g. in laboratories, schools, hospitals, the pharmaceutical industry, hairdressing salons and light industrial applications.

ME PP

Polypropylene joints and tube version. All metallic parts that are in contact with the air flow are made of stainless steel. The PP version of the ME is used primarily for evacuating very corrosive contaminants in high concentrations, e.g. in certain laboratories and in the pharmaceutical and chemical industries. When using a PP extractor fitted to a ceiling, we recommend that you order the MTI ceiling bracket with an internal epoxy coating.

ME ATEX



Conductive polypropylene joints and tubes. All metallic parts that are in contact with the air flow are made of stainless steel. Static electricity is diverted to a separate earth connection. All steel supporting parts are lined in a conductive powder coating. The product meets the requirements of category 2 of the ATEX directive (94/9/EC) for gases and dust.

The ATEX version of the ME is suitable for evacuating airborne contaminants where there is a requirement for ATEX-classified products, e.g. laboratories, the chemical and petrochemical industries, gas distribution, and the paint and pharmaceutical industries.

Delivery

Ceiling-MET Supplied assembled, excluding hood. The MTI or MTF ceiling brackets should be ordered separately.

Wall-MEV Supplied assembled, complete with MVK wall bracket, excluding hood.

Table-MEB Supplied assembled, with attachment plate for table fitting, excluding hood. The MBF flexible table bracket should be ordered separately.

FUMEX®

Verkstadsvägen 2, 931 61 SKELLEFTEÅ
Skellefteå : Tel : 0910-361 80, Fax 0910-130 22
www.fumex.com info@fumex.se